

СИСТЕМЫ ВПРЫСКА ГАЗА LOVATO



EASY FAST OBD-II



EASY FAST OBD-II ECU

2-3-4 цили

5-6-8 цили

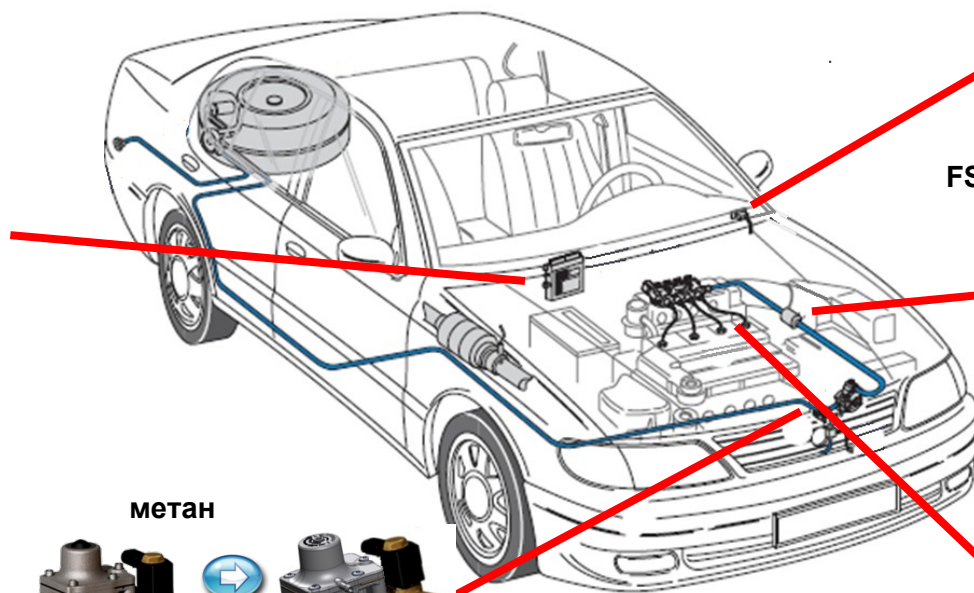

Кнопка переключения топлива Lovato



FSU фильтр (PT - MAP сенсор)



пропан

метан

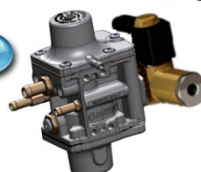

RGJ-3.2

RGJ HP/SHP

RMJ-3

=>

RMJ-3.2

Газовые редукторы RMJ-3.2 HP

Инжекторная рейка LOVATO тип KP



штуцеры

EASY FAST OBD-II LPG			INJECTOR TYPE		REDUCER			HIGH PRESSURE PIPE	
	CODE	DESCRIPTION	JP	KP	RGJ-3.2 L	HP	SHP	φ 6x4	φ 8x6
KIT	604710001	KIT GPL EASY FAST 3 OBD-II KP	-	X	X	-		X	-
	604700872	KIT GPL EASY FAST 4 OBD-II KP	-	X	X	-		X	-
	604700873	KIT GPL EASY FAST 4 OBD-II KP HP	-	X	-	X		-	X
	604710004	KIT GPL EASY FAST 5 OBD-II KP	-	X	X	-		-	X
	604700898	KIT GPL EASY FAST 6 OBD-II KP	-	X	X	-		-	X
	604710005	KIT GPL EASY FAST 6 OBD-II KP HP	-	X	-	X		-	X
	604710501	KIT GPL EASY FAST 6 OBD-II KP SHP	-	X	-	-	X	-	X
	604710008	KIT GPL EASY FAST 8 OBD-II KP HP	-	X	-	X		-	X
	604710502	KIT GPL EASY FAST 8 OBD-II KP SHP	-	X	-	-	X	-	X
MINIKIT	604710002	MINIKIT GPL EASY FAST 4 OBD-II KP	-	X	X	-		-	-
	604710003	MINIKIT GPL EASY FAST 4 OBD-II KP HP	-	X	-	X		-	-
	604710006	MINIKIT GPL EASY FAST 6 OBD-II KP	-	X	X	-		-	-
	604710007	MINIKIT GPL EASY FAST 6 OBD-II KP HP	-	X	-	X		-	-
	604710009	MINIKIT GPL EASY FAST 8 OBD-II KP HP	-	X	-	X		-	-

EASY FAST OBD-II CNG			INJECTOR TYPE		REDUCER		HIGH PRESSURE PIPE	
	CODE	DESCRIPTION	JP	KP	RMJ-3		STD Steel pipe	
KIT	604800208	KIT CNG EASY FAST 3 OBD-II KP	-	X	X		X	
	604800209	KIT CNG EASY FAST 4 OBD-II KP	-	X	X		X	
	604800210	KIT CNG EASY FAST 5 OBD-II KP	-	X	X		X	
	604800211	KIT CNG EASY FAST 6 OBD-II KP	-	X	X		X	
	604800212	KIT CNG EASY FAST 8 OBD-II KP	-	X	X		X	
MINIKIT	604800205	MINIKIT CNG EASY FAST 4 OBD-II KP	-	X	X		-	
	604800206	MINIKIT CNG EASY FAST 6 OBD-II KP	-	X	X		-	
	604800207	MINIKIT CNG EASY FAST 8 OBD-II KP	-	X	X		-	

SMART P/T

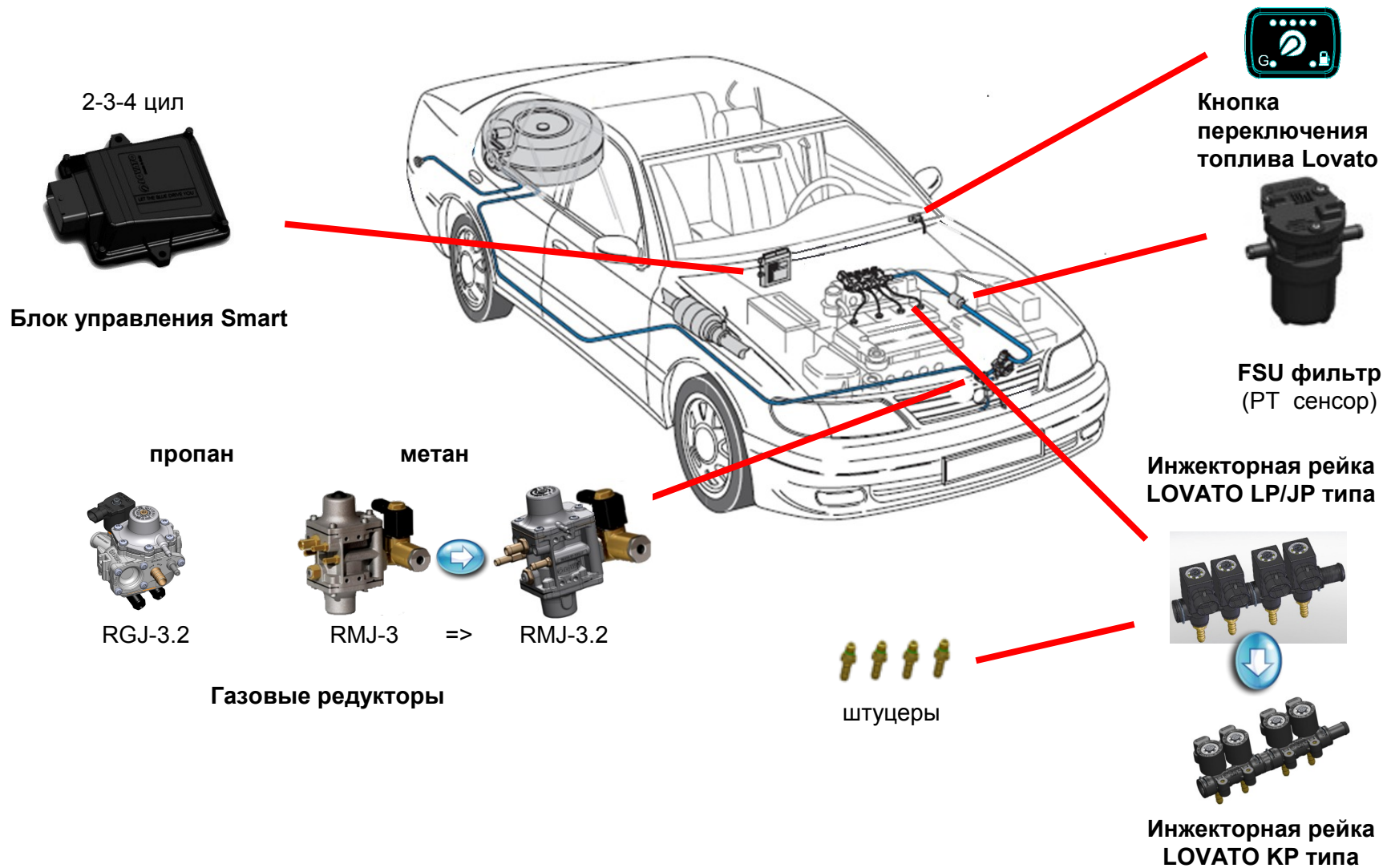

SMART P/T/MAP

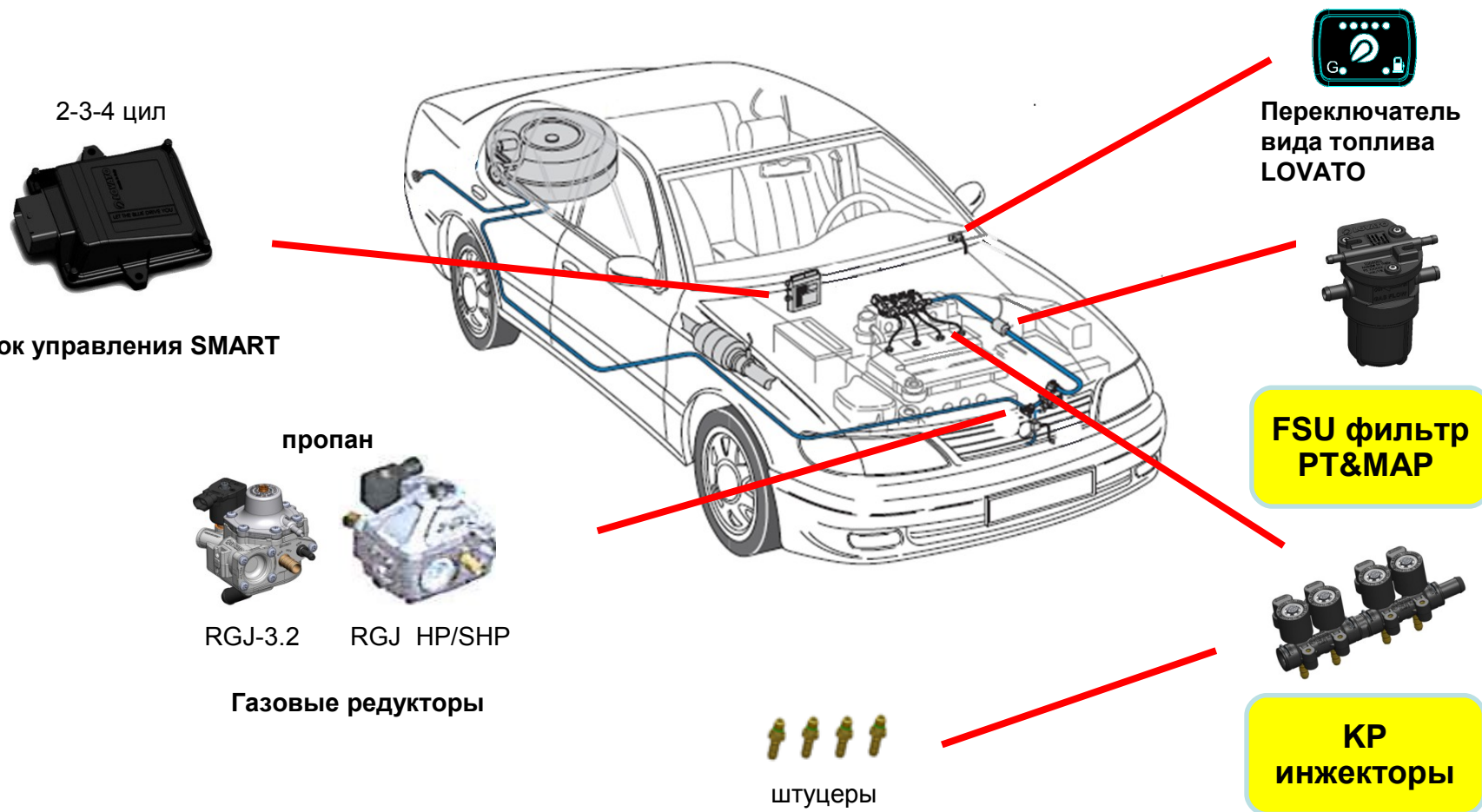

КОДЫ SMART



SMART LPG			INJECTORS TYPE			REDUCER		PNEUMATIC ACCESSORY		PIPES		
	CODE	DESCRIPTION	LP	JP	KP	RGJ-3.2 L	HP	MINIKIT	COMPLETE	RUBBER	COPPER	FLEX
SMART PT FILTER	604710089	MINIKIT GPL EASY FAST SMART 3 PT	X	-	-	X	-	X	-	-	-	-
	604710090	MINIKIT GPL EASY FAST SMART 3 JP PT	-	X	-	X	-	X	-	-	-	-
	604700091	MINIKIT GPL EASY FAST SMART 4 PT	X	-	-	X	-	X	-	-	-	-
	604710092	MINIKIT GPL EASY FAST SMART 4 JP PT	-	X	-	X	-	X	-	-	-	-
	604710093	KIT GPL EASY FAST 4 SMART S\TUBO RAME PT	X	-	-	X	-	X	-	X	-	-
	604710094	KIT GPL EASY FAST 4 SMART JP PT	-	X	-	X	-	-	X	X	∅ 6x4	-
	604710095	MINIKIT GPL EASY FAST SMART 4 HP PT	X	-	-	-	X	X	-	-	-	-
	604710096	MINIKIT GPL EASY FAST SMART 4JP HP PT	-	X	-	-	X	X	-	-	-	-
	604710097	KIT GPL EASY FAST SMART 4 HP S\TUBO RAME PT	X	-	-	-	X	X	-	X	-	-
	604710098	KIT GPL EASY FAST SMART 4HP S/TUBO PT	-	X	-	-	X	-	X	X	∅ 8x6	-
604710536	KIT GPL EASY FAST SMART 4 JP PT TRM	-	X	-	X	-	-	X	X	-	x equiv 4x6	
SMART FSU FILTER	604710108	MINIKIT GPL EASY FAST SMART 4 LP CMAP	X	-	-	X	-	X	-	-	-	-
	604710506	MINIKIT GPL EASY FAST SMART 4 KP MAP	-	-	X	X	-	X	-	-	-	-
	604710034	MINIKIT GPL EASY FAST SMART 4 KP HP MAP	-	-	X	-	X	X	-	-	-	-
	604710237	KIT GPL EASY FAST SMART FIAT 0,9 TWINAIR	-	-	X	X	-	-	X	X	∅4x6	-
	604710500	KIT GPL EASY FAST SMART 4 JP CMAP	-	X	-	X	-	-	X	X	∅4x6	-
	604710507	KIT GPL EASY FAST SMART 4 KP MAP	-	-	X	X	-	-	X	X	∅ 8x4	-
	604710057	KIT GPL EASY FAST SMART 4 KP HP C/MAP	-	-	X	-	X	-	X	X	∅ 8x6	-
SMART CNG			INJECTORS TYPE			REDUCER		PNEUMATIC ACCESSORY		PIPES		Di.Ba. 5
	CODE	DESCRIPTION	LP	JP	KP	RMJ-3		MINIKIT	COMPLETE	Rubber	Steel	
SMART PT FILTER	604800214	MINIKIT CNG EASY FAST SMART 3 JP NO MAP	-	X	-	X		X	-	-	-	-
	604800215	MINIKIT CNG EASY FAST SMART 4 JP NO MAP	-	X	-	X		X	-	-	-	-
	604800216	KIT CNG EASY FAST 4 SMART JP S\TUBO ACCIAIO NO MAP	-	X	-	X		X	-	X	-	-
	604800233	KIT CNG EASY FAST SMART 4 JP PT	-	X	-	X		-	X	X	X	-
	604800274	MINIKIT CNG E-FAST SMART 4 JP s\MAN conf	-	X	-	X		X	-	-	-	-
	604800244	MINIKIT CNG EASY FAST SMART 4 JP IS	-	X	-	X		X	-	-	-	X

E-GO

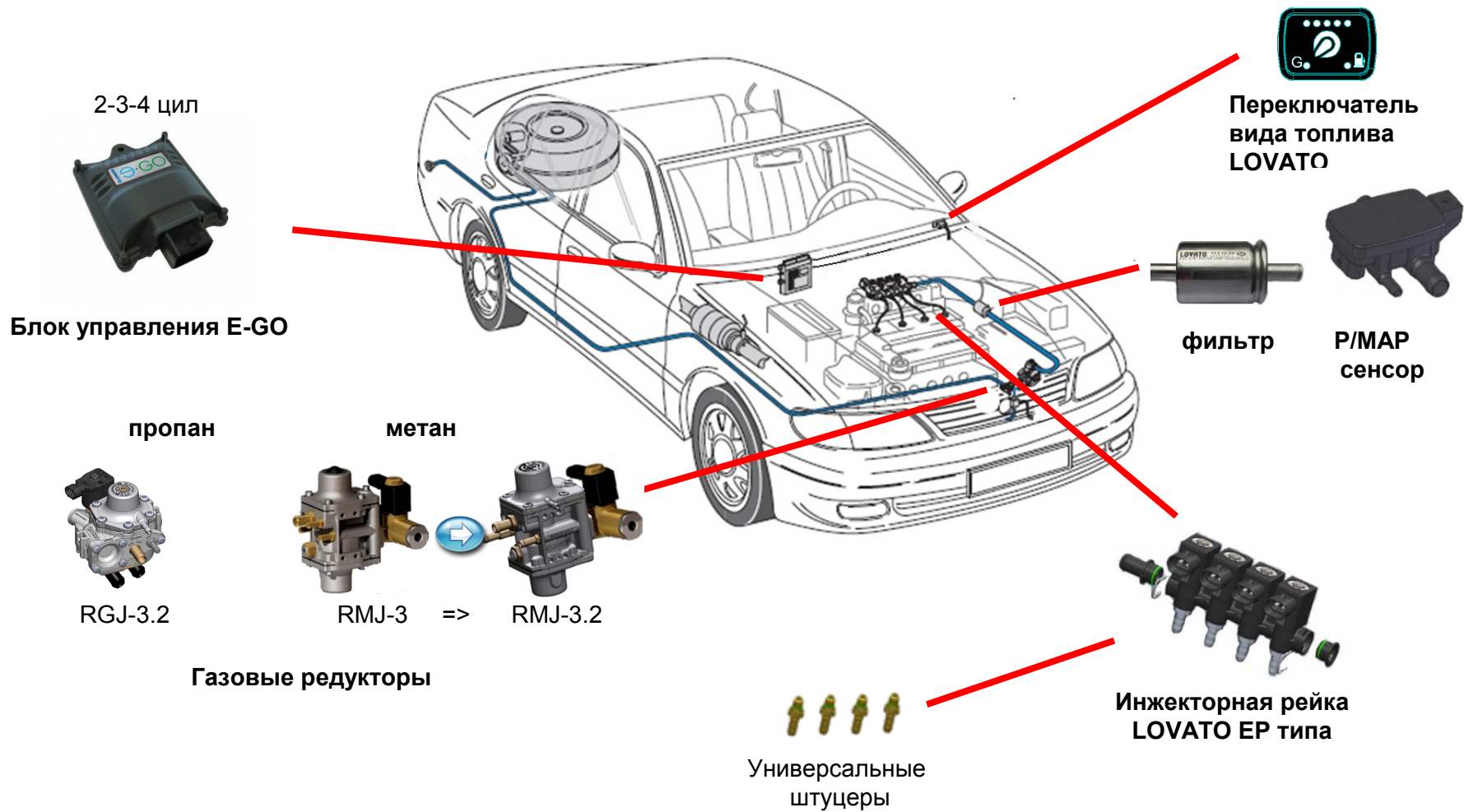

КОДЫ E-GO



E-GO GPL			INJ	REDUCER	PNEUMATIC ACCESSORY		PIPES		
	CODE	DESCRIPTION	EP	RGJ-3.2 L	MINIKIT	COMPLETE	RUBBER	COPPER	FLEX
GPL	604710652	MINIKIT GPL E-GO 4	x	x	x	-	-	-	-
	604710656	KIT GPL E-GO 4	x	x	-	x	x	x	-
E-GO CNG			INJ	REDUCER	PNEUMATIC ACCESSORY		PIPES		Di.Ba. 5
	CODE	DESCRIPTION	EP	RMJ-3	MINIKIT	COMPLETE	Rubber	Steel	
CNG	604800862	MINIKIT CNG E-GO 4	x	x	x	-	-	-	-
	604800866	KIT CNG E-GO 4	x	x	-	x	x	x	-

ПРЯМОЙ ВПРЫСК EASY FAST D.I.



3-4 цилиндр



Блок управления EASY FAST D.I.



Переключатель вида топлива LOVATO

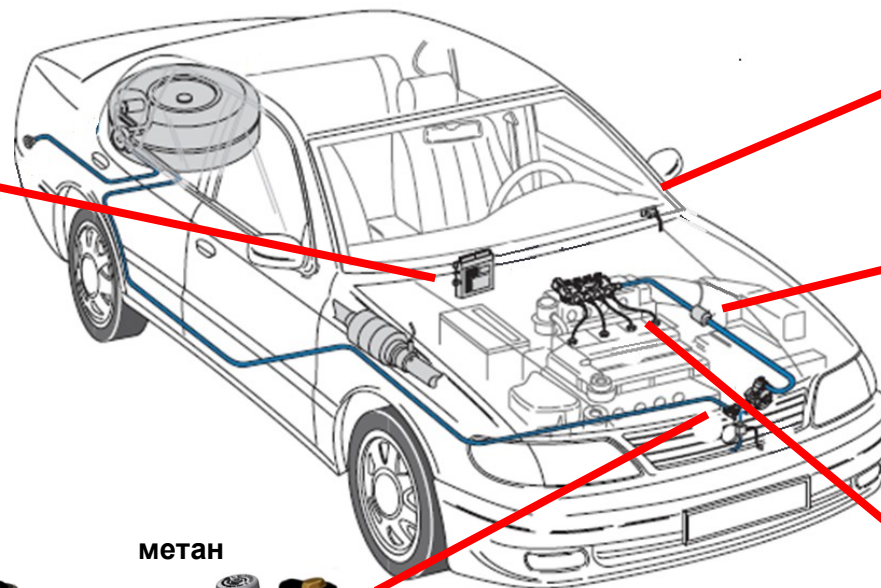

FSU фильтр (PT - MAP сенсор)

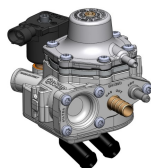

пропан
RGJ-3 DD

метан



RGJ-3.2



RGJ HP



RMJ-3



=>

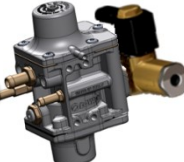

RMJ-3.2

Газовые редукторы



штуцеры



Инжекторные рейки LOVATO KP-типа

ГАЗОДИЗЕЛЬ



D.D.F ECU



FUEL SWITCH



FSU GAS FILTER



RGJ-3.2 or RMJ-3.2
PRESSURE REGULATOR



MAP AND GAS
PRESSURE SENSORS



KP INJECTORS (2) RAIL

Коды DUAL FAST



DUAL FAST LPG		INJ	REDUCER			PNEUMATIC ACCESSORY		PIPES	
CODE	DESCRIPTION	KP	RGJ-3.2 L	RGJ-3.2 DD	RGJ-HP	MINIKIT	COMPLETE	RUBBER	COPPER
604710651	KIT GPL DUAL FAST	x	x	-	-	-	x	x	x

DUAL FAST CNG		INJ	REDUCER			PNEUMATIC ACCESSORY		PIPES	
CODE	DESCRIPTION	KP	RMJ-3.2			MINIKIT	COMPLETE	Rubber	Steel
604800861	KIT CNG DUAL FAST	x	x			-	x	x	x

LSU LAMBDA *

код 203954000

LSU CALIBRATION KIT

* Это оптимальный комплект для калибровки автомобилей без лямбда сенсора

EASY FAST 10 цили



Кнопка переключения топлива



Блок управления EASY FAST 10цил



Редуктор пропан RGJ SHP



FSU фильтр



P/MAP сенсор

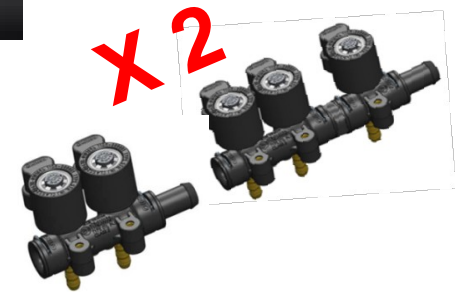

Инжекторные рейки LOVATO КР-типа & Датчик температуры газа

**Available only
Minikit
EASY FAST 10 cyl
604710033**

штуцеры



Характеристики редукторов пропан



RGJ-3.2
=> RGJ-3.2 L



RGJ HP / SHP

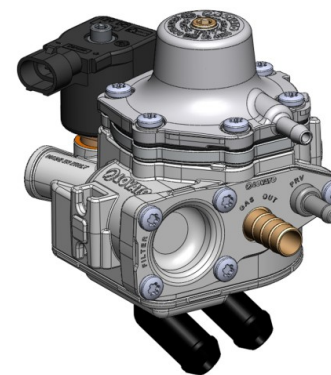

RGJ-3 DD
=> RGJ-3.2 L DD

⌚	RGJ	$P_{\text{gas}} = 1.0 \text{ Bar} \leq 100 \text{ kW}$
⌚	RGJ-3.2	$P_{\text{gas}} = 1.0 \text{ Bar} \leq 120 \text{ kW}$
⌚	RGJ HP	$P_{\text{gas}} = 1.0 \text{ Bar} \leq 220 \text{ kW}$
⌚	RGJ SHP	$P_{\text{gas}} = 1.2 \text{ Bar} \leq 260 \text{ kW}$
⌚	RGJ-3 DD	$P_{\text{gas}} = 0.7-1.4 \text{ Bar} \leq 120 \text{ kW}$

Коды редукторов пропан



RGJ-3.2 L
С июня 2013

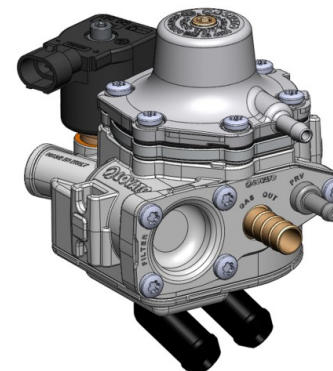

RGJ-3
536772000
RGJ-3.2 536795000
RGJ-3.2 L 536795000
RGJ (старого типа) 1624005

RGJ-3 DD 536773000
RGJ-3.2 DD 536778000



RGJ HP 536771000
RGJ SHP 536902000

HGJ HP

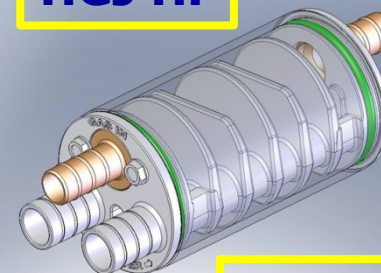

1630001

Коды ремкомплектов редукторов RGJ-3 & 3.2

код	название	Применение после пробега
674997000	Ремкомплект редуктора "А"	50.000 km
674998000	Ремкомплект редуктора "В"	100.000 km
674999000	Ремкомплект редуктора "С"	150.000 km

A

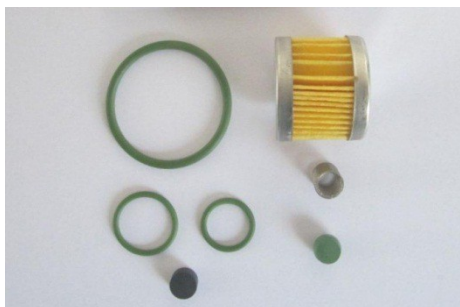

B



C

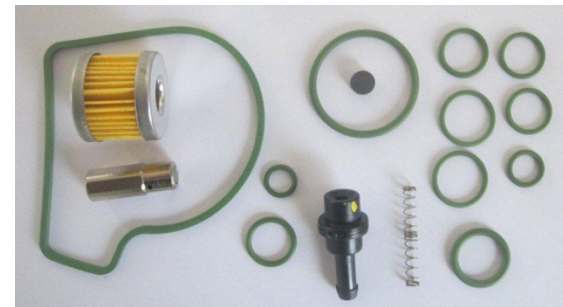

Коды ремкомплектов редуктора RGI-3.2 L



код	название	Применение поле пробега
674000100	Ремкомплект редуктора "А"	50.000 km
674000101	Ремкомплект редуктора "В"	100.000 km
674000102	Ремкомплект редуктора "С"	150.000 km

Коды ремкомплектов редуктора RGJ-3.2 DD

код	название	Применение после пробега
674997000	Ремкомплект редуктора "А"	50.000 km
674996000	Ремкомплект редуктора "В"	100.000 km
674999000	Ремкомплект редуктора "С"	150.000 km

A

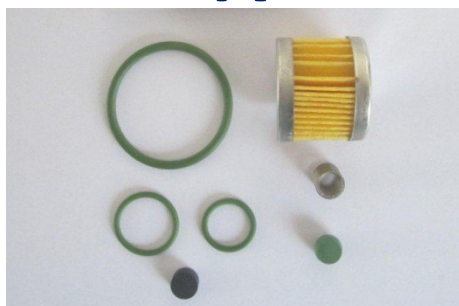

B



C



Коды ремкомплектов редуктора RGJ HP & SHP



Код	Название	Применение после пробега
674705000	Ремкомплект редуктора "А"	50.000 km
674706000	Ремкомплект редуктора "В"	100.000 km
674707000	Ремкомплект редуктора "С"	150.000 km

A



B



C



Редукторы метан



RMJ-3

- **1620003** (до 2010)
- **536896000** (с 2010)



RMJ-3.2

536800004



RMJ-3.2 HP

536800029

- ⌚ **RMJ-3** **$P_{\text{gas}} = 1.8 \text{ bar} \leq 140 \text{ kW}$**
- ⌚ **RMJ-3.2** **$P_{\text{gas}} = 1.8 \text{ bar} \leq 140 \text{ kW}$**
- ⌚ **RMJ-3.2 HP** **$P_{\text{gas}} = 1.8 \text{ bar} \leq 200 \text{ kW}$**

- ⌚ ***RMJ O.E.M. Application (2.0 Bar / SENSATA HP GAUGE)***

Ремкомплекты редукторов RMJ-3 & 3.2

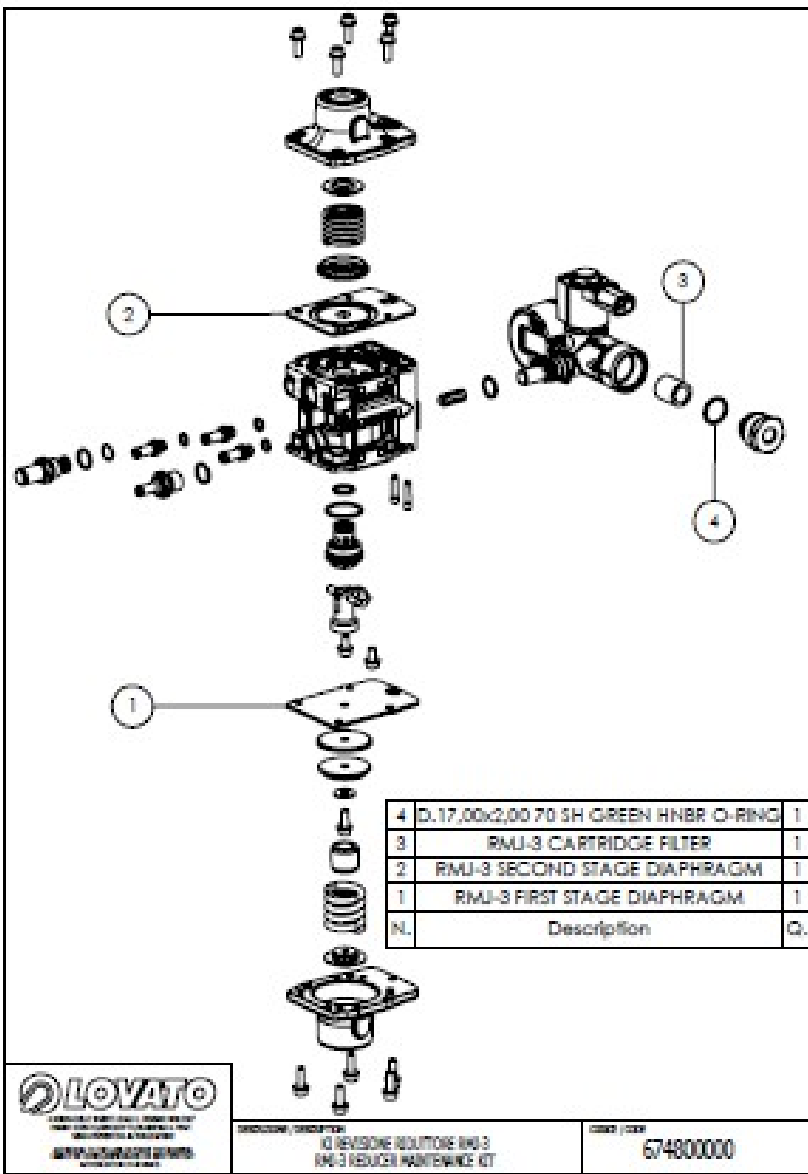

**Применяются после каждых
60.000 км пробега**

RMJ-3

код 1294022

(код 1624003)

RMJ-3

код

674800000

(код 536896000)

RMJ-3.2

код 674709000



LOVATO INDUSTRIAL SOLUTIONS
CORPORATION
10000 WILSON AVENUE
MILWAUKEE, WI 53222-1000
USA
WWW.LOVATO.COM

DESCRIPTION / DESCRIPTION

10 REVISIONE SOLUZIONI RMJ-3
RMJ-3 REDUCER MAINTENANCE KIT

CODE / CODE

674800000

Инжекторы



**LP/JP тип – 2/3 цилиндров,
ремонтные**



**EP тип – 4 цилиндра,
ремонтные**

**В состав рейки входят
штуцеры**

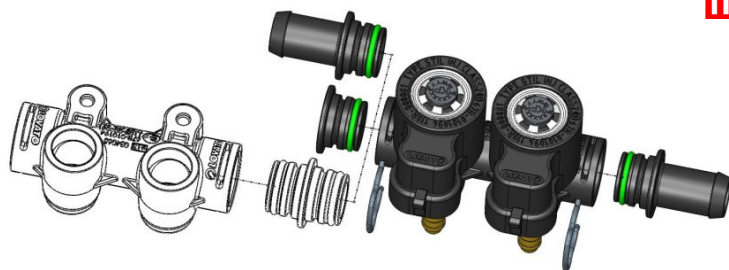

KP тип – 2/3 цилиндра



штуцеры
Размеры от A1 до H
Универсальный
размер A1 (EP тип)

КОДЫ ИНЖЕКТОРОВ



форсунка КР	237113000
форсунка JP	237112000
форсунка LP	232027000
форсунка EP	232076000
рейка 2 цили КР	238606000
рейка 3 цили КР	238607000
рейка 2 цили JP	1040022
рейка 3 цили JP	238604000
рейка 2 цили LP	238603000
рейка 4 цили EP	238636000

Комплекующие рейки

КОД	название	фото
4770011	заглушка M16X1 W/HNBR с рез. кольцом	
4530023	Входной фиттинг рейки D.12 с рез. кольцом	
4020001	Фиксатор для соединения рейки CONNECTION	
4590020	Соединитель рейки 2x2 с рез. кольцом	
240104300	Рампа на 4 форунки EP	
3161001	Рампа на 2-форсунки	
235101000	Монорампа	

- Упаковка штуцеров для рейки D.1,4 'A1' 668108000
- Упаковка штуцеров для рейки D.1,6 'A' 668109000
- Упаковка штуцеров для рейки D.1,8 'B' 668110000
- Упаковка штуцеров для рейки D.2,0 'C' 668111000
- Упаковка штуцеров для рейки D.2,2 'D' 668112000
- Упаковка штуцеров для рейки D.2,4 'E' 668113000
- Упаковка штуцеров для рейки D.2,6 'F' 668114000
- Упаковка штуцеров для рейки D.2,8 'G' 668115000
- Упаковка штуцеров для рейки D.3,0 'H' 668116000

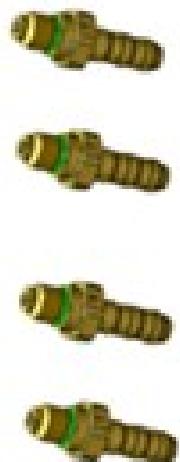

Ремкомплекты EP форсунок



Обслуживание рейки производится с помощью набора для обслуживания EP форсунок и запасных частей (код 674701000)



**Ремкомплекты
EP - LP
форсунок**

674700000 "A" KIT:
включает все прокладки, и др. для стандартного обслуживания рейки 4 цили.

674702000 "B" KIT: *предназначен для увеличения срока эксплуатации после многократного обслуживания.*

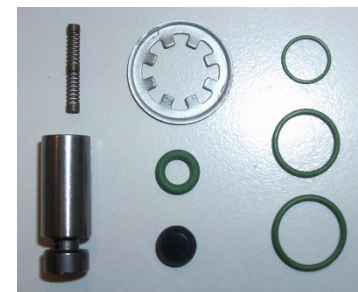
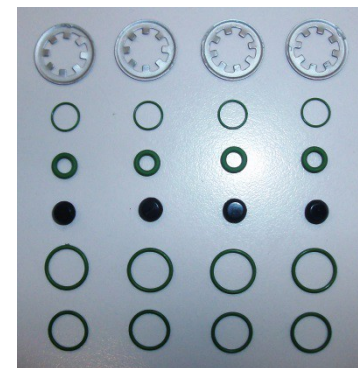

Датчики и фильтры

421053



203850000



668117000



Датчик воды

1205010



**FSU фильтр
PT-MAP сенсор**

161511000



**FSU фильтр
PT-сенсор**

1205005



**FSU фильтр
Без датчика**

530050000



**Датчик темп. газа
для пластиковой
рейки**

463532000



**PT-MAP сенсор
(E-GO)**

161523000



**Одноразовый
фильтр
(E-GO)**



1294021

**Ремкомплект фильтра
(картридж + прокладки)**

4720017
1720040 conf.



OBD-II
5/6/8 цил

4720016
1720039 conf.



OBD-II
2/3/4 цил

4720012
616972000 conf.



D.I.
3/4 цил



D.I.
5/6/8 цил

616497000



SMART 2/3/4 цил

616000167



E-GO 2/3/4 цил

616000170



DUAL FAST

616481000



10 цил